

KORAL MODULAR

ASSEMBLY INSTRUCTIONS

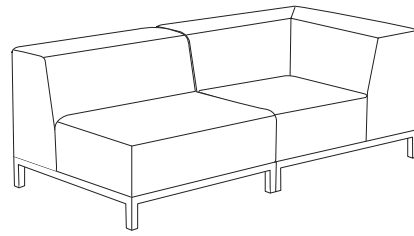

**CONNECTING HARDWARE FOR EACH MODULE**

**A** Connector Bracket  
Quantity: 8

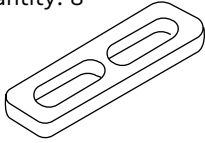

**B** Connector Bolt  
Quantity: 16

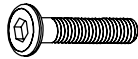

**C** Allen Wrench  
Quantity: 1

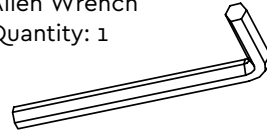

**MODULE CONNECTION**

Each base module is equipped with two low profile insert nuts on each side (totaling 8 per base). 8 connector brackets and 16 connector bolts are included to connect ANY possible side of the base module. You may have more hardware than what is needed based on the configuration you have chosen.

**CONNECTING TWO OR MORE MODULAR UNITS**

Lay units to be connected on their sides or backs on a clean, flat surface, such as provided cardboard box or blanket, to protect the surfaces from scratches. Align the low profile insert nuts of two adjacent modules and connect them using the provided bracket and connecting bolts. Loosely tighten bolts and brackets. Repeat process for each module you wish to connect. Secure bolts tightly with the allen wrench. Return joined units to their upright standing position.

NOTE: For stability and safety, it is essential that all units be secured to each other using the supplied hardware.

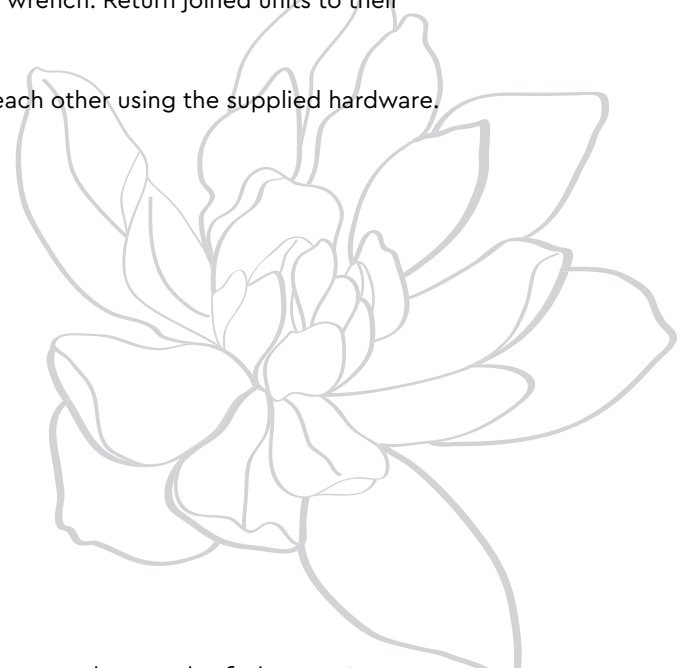
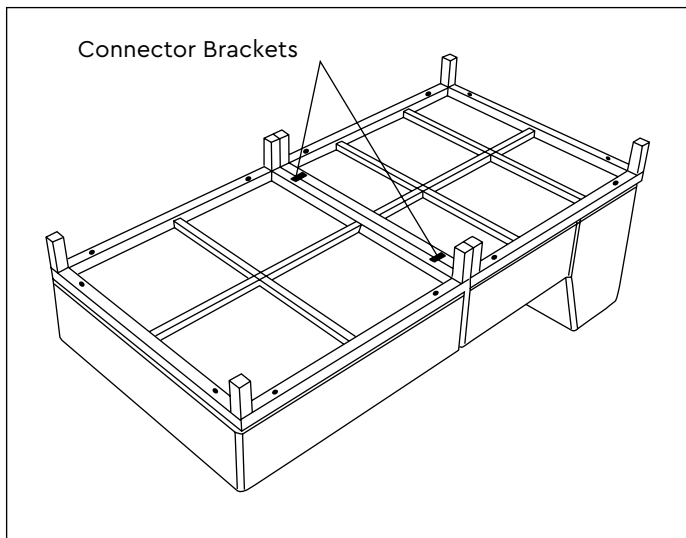

Thoughtful Design **MADE RIGHT**

## BRACKET PLACEMENT

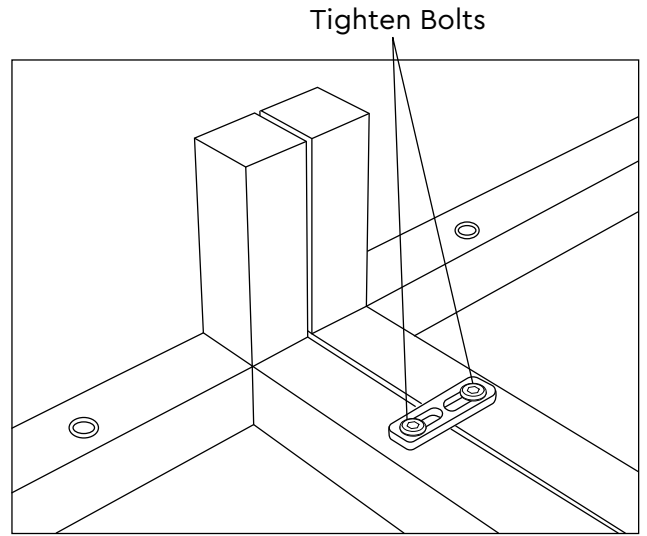
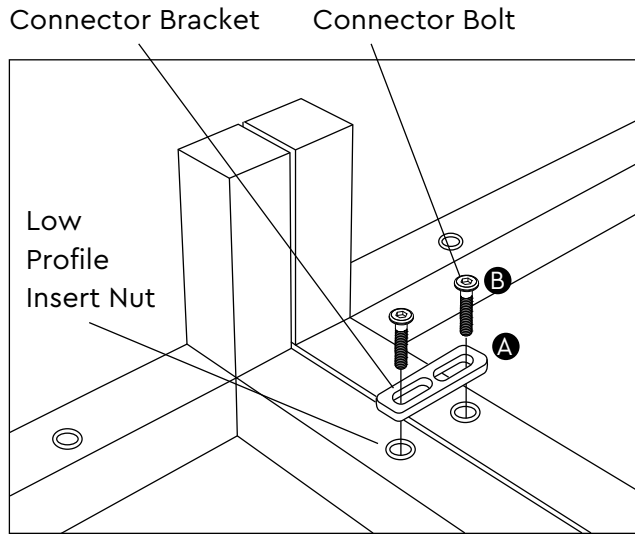

## BASE MODULES

Corner Seat

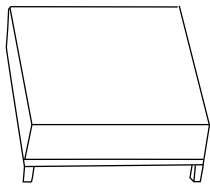

Side Chair

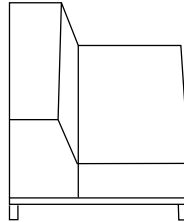

Ottoman

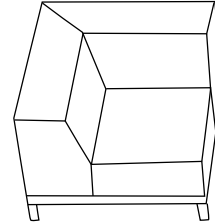

## POSSIBLE CONFIGURATIONS

